

DATOS DE MEDICIÓN PARA PERSIANAS DE OBRA

ALTO

ANCHO

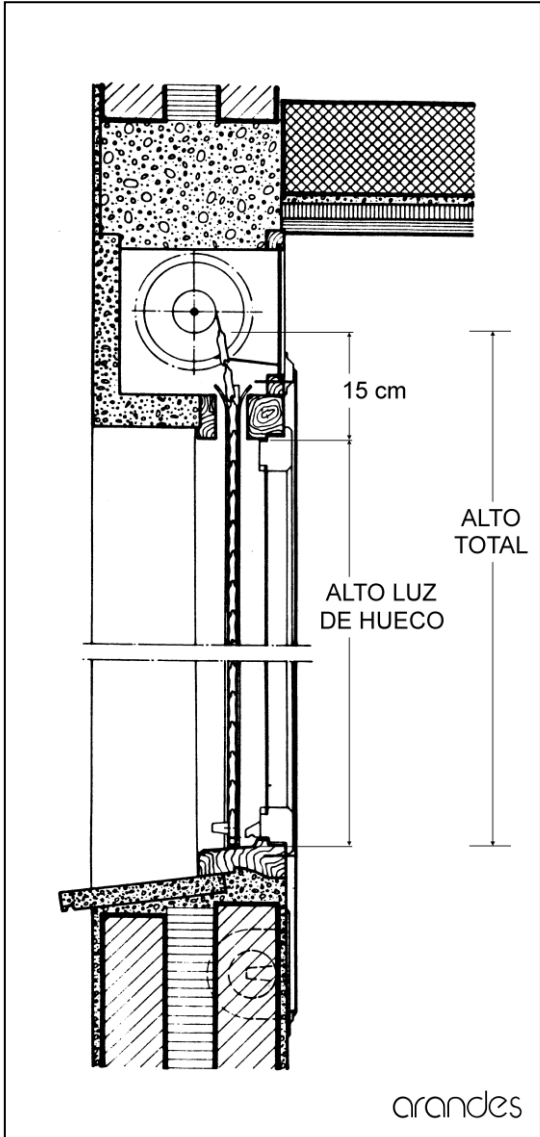

PERSIANAS DE P.V.C. y MADERA

SOBRE GUIAS EXISTENTES DE 20x20

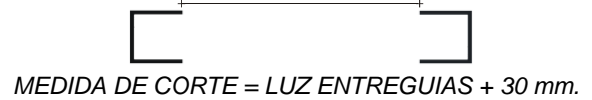
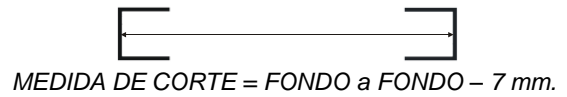

SOBRE MARCO EXISTENTE

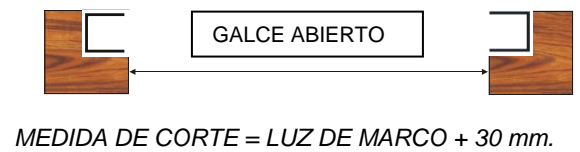
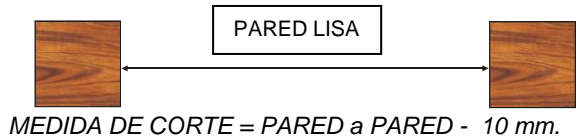

PERSIANAS DE ALUMINIO

PARA COLOCACIÓN DE CONTRAGUÍAS SOBRE GUIAS EXISTENTES DE 20x20

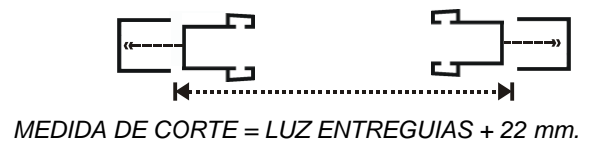
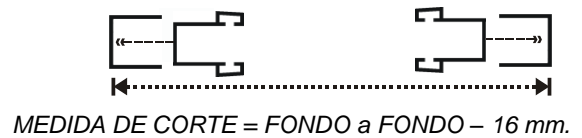

PARA COLOCACIÓN DE GUIAS VISTAS

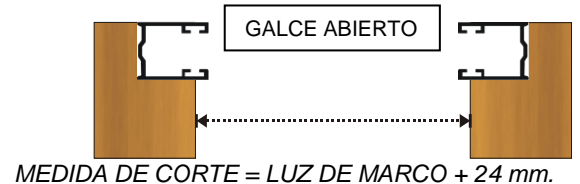
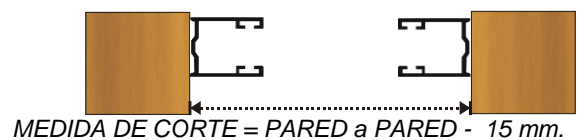

PARA EVITAR ERRORES :
TODAS LAS MEDIDAS SE DEBEN DE PASAR COMO MEDIDAS YA A FABRICAR:
ALTO TOTAL x ANCHO AL CORTE